

WITH HAND SHOWER AND BATH OVERFLOW FILLER - GRAVITY PUMPED

DIMENSIONAL DRAWINGS

SHOWER HOSE

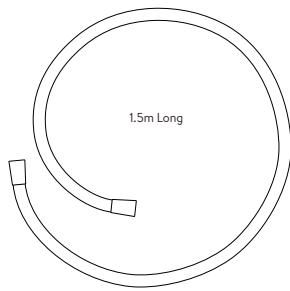

HAND SHOWER AND BRASS WALL OUTLET

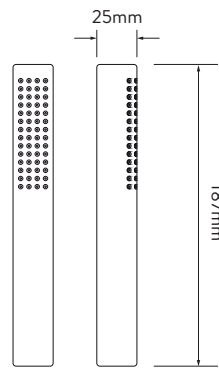

CONTROLLER

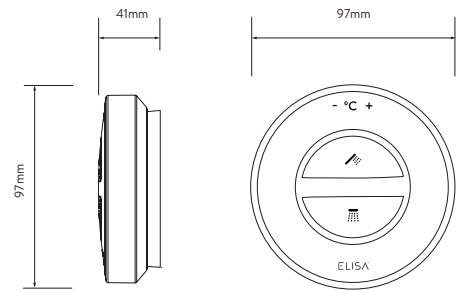

REMOTE

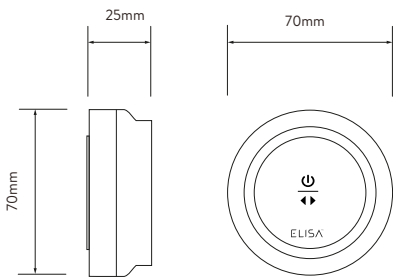

SMARTVALVE

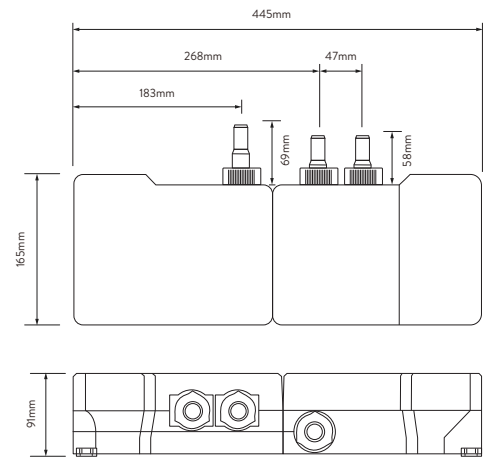

BATH OVERFLOW FILLER

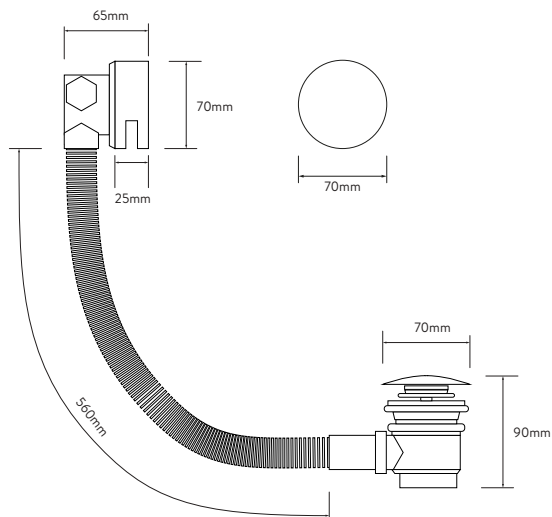

DIVERTER

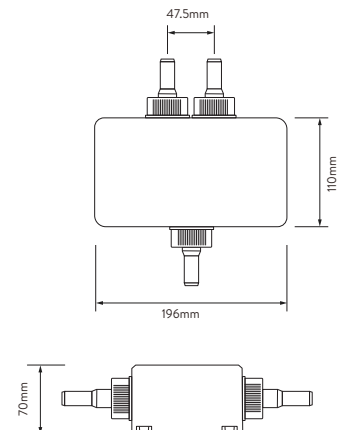

WITH HAND SHOWER AND BATH OVERFLOW FILLER - GRAVITY PUMPED

TECHNICAL SPECIFICATIONS

Minimum pressure requirements	SmartValve must be sited no higher than the base level of the cold water system
Maximum pressure requirements	1 bar (Gravity)
SmartValve inlet fitting connections	15mm push fit fittings, valve inlet centres 48mm, inlet supply positions – hot right, cold left
SmartValve and diverter outlet connections	15mm push fit
Permissible SmartValve and diverter siting locations	Loft, airing cupboard, under bath
Supply temperature	Cold inlet temperature 1°C (minimum) Cold inlet temperature 15°C (maximum) Hot inlet temperature 65°C (maximum)
Water system	Gravity
Features	One touch start/stop control
	LED display indicates when pre-selected temperature has been reached
	Wi-Fi & App compatible – control your product with your smart phone and smart home device e.g. Alexa
	App functions include start/stop, shower timer, user dashboard, usage tracker and help & support
	SmartValve
	Digital diverter technology
	300mm drencher and slim hand shower
Guarantee period	Compatible with wired remote control
	5-year guarantee - shower unit
Approvals	2-year guarantee - shower head and kit
	CE Marking
	UKCA
	BEAB