

WITH HAND SHOWER AND WALL FIXED DRENCHER - GRAVITY PUMPED

DIMENSIONAL DRAWINGS

WALL FIXED DRENCHER

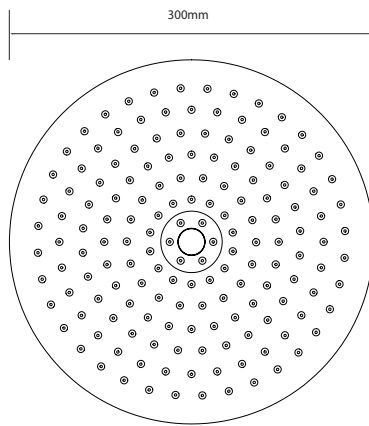

CONTROLLER

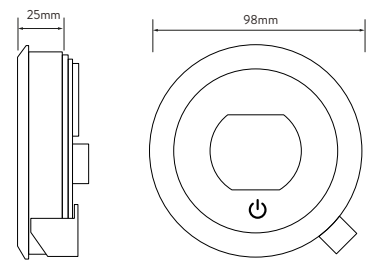

FIX WALL ARM

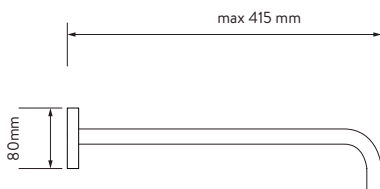

SMARTVALVE

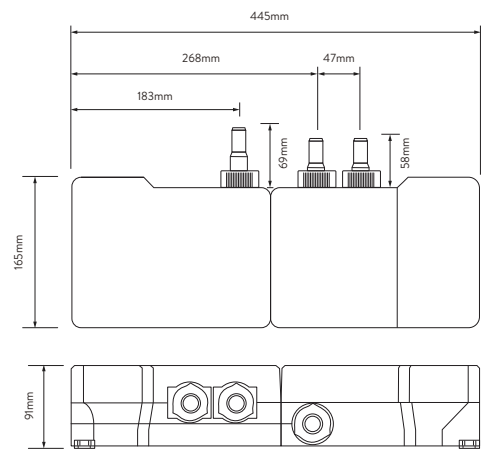
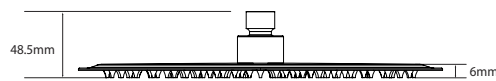

SHOWER HOSE

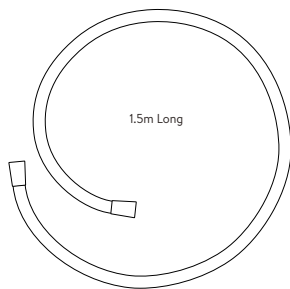

HAND SHOWER AND BRASS WALL OUTLET

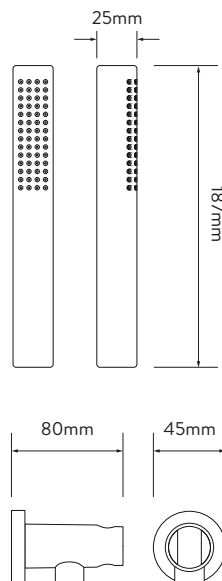

DIVERTER

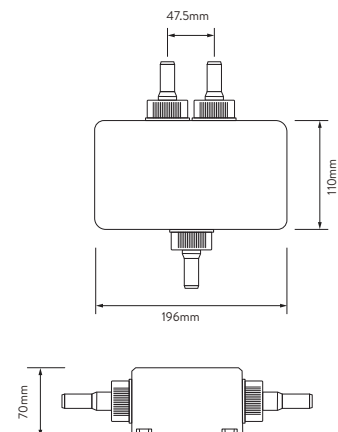

REMOTE

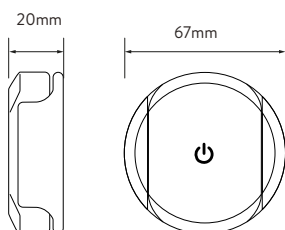

WITH HAND SHOWER AND WALL FIXED DRENCHER - GRAVITY PUMPED

TECHNICAL SPECIFICATIONS

Minimum pressure requirements	SmartValve must be sited no higher than the base level of the cold water system
Maximum pressure requirements	1 bar (Gravity)
SmartValve inlet fitting connections	15mm push fit fittings, valve inlet centres 48mm, inlet supply positions – hot right, cold left
SmartValve and diverter outlet connections	15mm push fit
Permissible SmartValve and diverter siting locations	Loft, airing cupboard, under bath
Supply temperature	Cold inlet temperature 1°C (minimum) Cold inlet temperature 15°C (maximum) Hot inlet temperature 65°C (maximum)
Water system	Gravity
Features	Proximity sensor (to wake controller up)
	Large rotary temperature ring
	Digital display system
	User definable shower profiles / experiences (available via the Lisa App)
	Warm and ready indicator
	Optical on off switch
	Unique lever control
	Magnetically damped lever
	300mm drencher and slim hand shower
	Wi-Fi & App compatible – control your product with your smart phone and smart home device e.g. Alexa
	App functions include start/stop, set your flow and temperature, shower timer, user dashboard, usage tracker and help & support
	SmartValve
	Wireless rechargeable remote control
	You can select the shower outlet you want to start first everytime
Digital diverter technology	
Guarantee period	5-year guarantee - shower unit
	2-year guarantee - shower head and kit
Approvals	CE Marking
	UKCA
	BEAB